

Article number: 03440015

Description: Fluro Rod end GE 15EC

## Measures

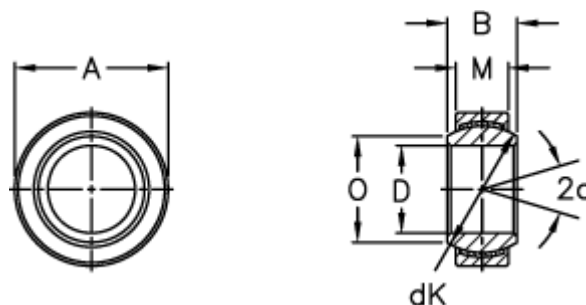

A	= 26 0 -0,009	Tilt angle = 8
B	= 12	Weight = 26
D	= 15 0 -0,008	
dK	= 22	
Dynamic load C (kN)	= 17.5	
M	= 9	
O	= 18.4	
Static load C0 (kN)	= 44	